

# RC-0801b

# VANXIE

## INSTALLATION MANUAL





### Caution

- Please make sure to read the Installation Guide before installing this product.
- Please do NOT modify or disassemble this product
- Please keep this product AWAY from children
- Please do NOT use this product for non-PC environment
- Please wear gloves during the installation to avoid injuries
- To prevent electrical shocks, please turn off system power and unplug the power cord of the system before the installation.

### 警告

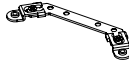
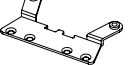
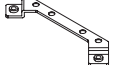
- ご使用前に必ず同梱の説明書をよくお読み下さい。
- 危険ですので、分解、改造等は絶対に行なわないで下さい。
- お子様の手の届く範囲内に本製品を保管しないで下さい。
- 想定した方法以外でのご使用はお止め下さい。
- 手を切る恐れがありますので、取付作業の感電の恐れがございますので、取り付けのコンセントを外した状態で取り付けを行ってください。

### Parts List

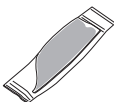
<b>A</b> Cooler 	<b>B</b> Clip for Intel CPU x2 	<b>C</b> Clip for AMD CPU x2 	<b>D</b> Clip for AMD (AM1) CPU x2 
<b>E</b> Clips Screw for Heatsink x 5 	<b>F</b> Silicon Washer x4 	<b>G</b> Screw dor Back Plate x4 	<b>H</b> Thermal Grease 

### Intel Socket 775, LGA 115x

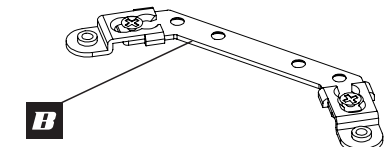

Screws already assembled for LGA 115X.

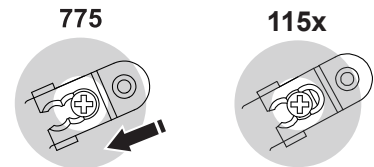

Please adjust screws positions for 775.

### 取り付け前にはがしてください。 Peel off before installation

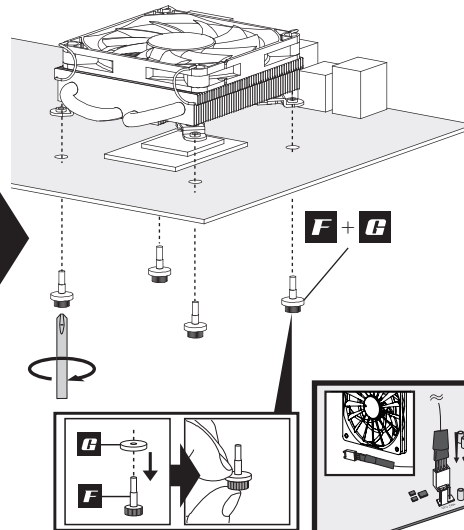
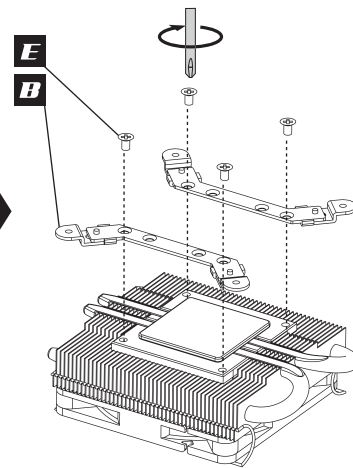
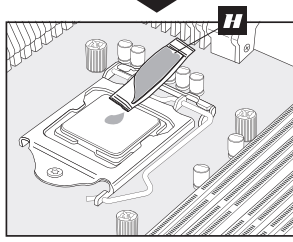
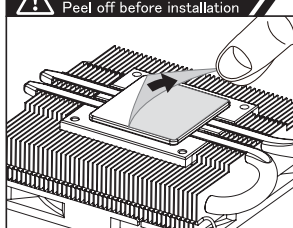

### AM1

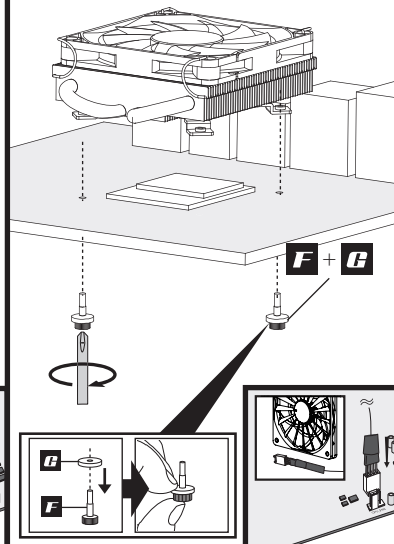
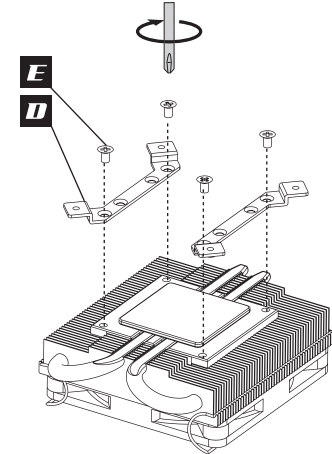

### AMD Socket AM2(+)/AM3(+)/FM1/FM2(+)

### 取り付け前にはがしてください。 Peel off before installation

